



INSTALLATION INSTRUCTIONS

Accessory	Application	Publications No.
DOOR MIRROR COVERS P/N 08R06-TX6-200	2016 ILX	VERSION 1
		Issue Date JAN 2015

PARTS LIST

Left door mirror cover



Right door mirror cover

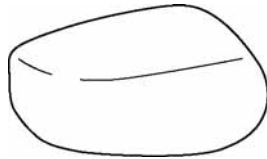

2 Alcohol swabs

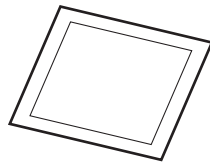

TOOLS AND SUPPLIES REQUIRED

Masking tape

INSTALLATION

NOTE:

- These instructions show the left door mirror cover being installed. The same procedure applies to installing the right door mirror cover.
- Be careful not to damage the paint finish.
- This door mirror covers kit should be installed only if the ambient air temperature is 15°C (60°F) or above.
- To allow the adhesive to cure, advise the client not to wash the vehicle for 24 hours.

1. Using an alcohol swab, thoroughly clean the area where the left door mirror cover will attach.

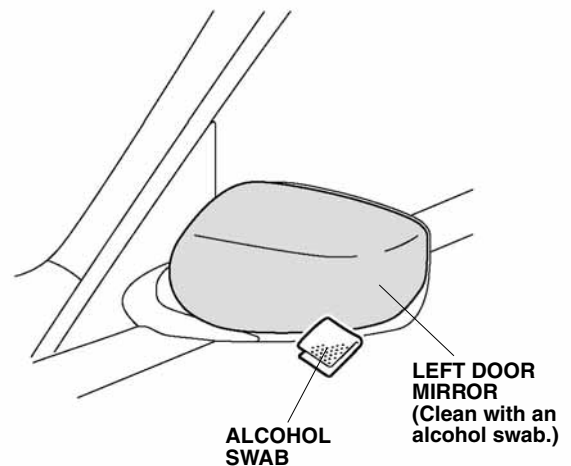

QD71601AT

2. Peel back the ends of seven adhesive backings on the left door mirror cover and attach them to the front of the cover with masking tapes.

7 ADHESIVE BACKINGS
(Peel back.)

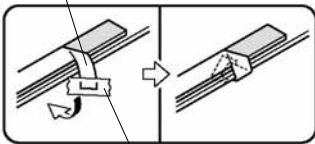

MASKING TAPE

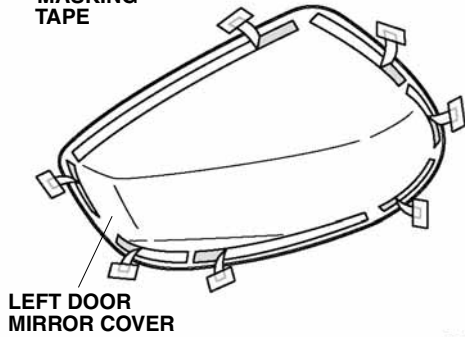

QD71602BT

3. Position the left door mirror cover on the left door mirror.

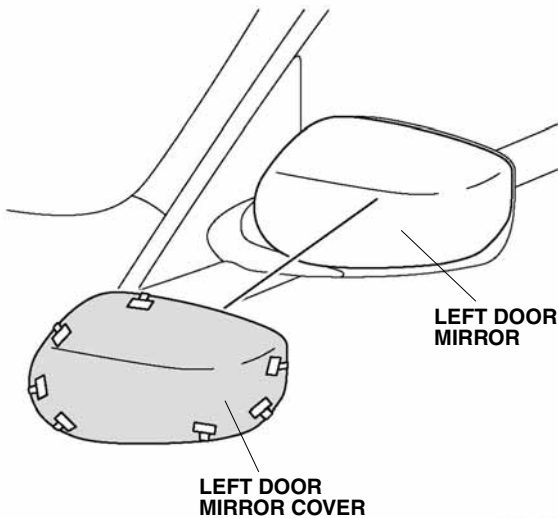

QD71603BT

4. While applying light pressure against the left door mirror cover, carefully remove the seven adhesive backings as shown. Then, firmly press the left door mirror cover against the left door mirror.

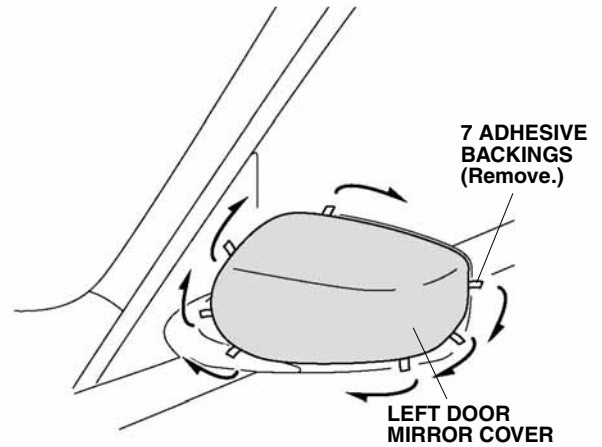

QD71604BT

5. Repeat steps 1 through 4 to install the right door mirror cover on the right side of the vehicle.